























11 Documents

Publication numbers	Title	Current assignees
US20070086199 A1	Combination white light and colored led light device with active ingredient emission	JOHNSON & SON
US20130127612 A1	Motor vehicle flashing light and method for operating a turn signal lamp	AUDI
US20120025970 A1	After market sequential turn signal	BEACH DONALD J, ...
US20100124073 A1	Rear combination lamp	FORD GLOBAL TECHNOLOGIES
DE102005049581 A1	Adapter for a light source and at least one alternative luminous means	PATRA PATENT TREUHAND
US7008096 B1	Colored headlamp	OSRAM SYLVANIA
WO200578335 A1	Lighting unit	PHILIPS ELECTRONICS
US20050099810 A1	Illumination device with arms that open after passing through a hole	LIAO RONNY, ...
US20040264187 A1	Lighting device	VANDERSCHUIT CARL R.
US6756893 B1	Light emitting diodes surrounding a vehicle lamp	FERNANDEZ ROBERT
DE19534410 A1	Sequential direction indicators for motor vehicles and street signs	GFK KUNSTSTOFFVERARBEITUNG

Combination white light and colored led light device with active ingredient emission US20070086199 A1

<p><u>Current assignees</u> JOHNSON & SON* JOHNSON MARK</p> <p><u>Inventors</u> DEMAREST SCOTT W ROBLING DARREN K NELSON CORY J WOLF JEFFREY J WALTER SCOTT D MINEAU STEVEN B ABBONDANZIO MATTHEW</p> <p><u>Priority data including date</u> 2003US-60483913 2003-07-02 2004US-10561822 2004-07-02 2004US-60549154 2004-03-03 2005US-11069964 2005-03-03 2006US-11426055 2006-06-23 2006US-11548921 2006-10-12 2006US-11548940 2006-10-12 2006US-11548957 2006-10-12 2006US-11553127 2006-10-26 2007US-11833488 2007-08-03 2007WO-US21798 2007-10-12 2007WO-US21926 2007-10-12 2007WO-US21929 2007-10-12 2007WO-US22730 2007-10-26 2008US-12057049 2008-03-27</p>	<p><u>IPC - International classification</u> A01M-001/20 A61L-009/01 A61L-009/03 B05B-007/16 B05B-017/00 F21K-099/00 F21S-008/00 F21S-010/02 F21V-019/00* F21V-023/00 F21V-023/04 F21V-033/00 H01J-005/54 H01J-061/70 H01K-001/46 H01R-033/94 H04R-001/02 H05B-035/00* H05B-037/02</p> <p><u>CPC - Cooperative classification</u> A01M-001/20/77 A01M-001/20/83 A61L-009/03* A61L-009/03*/7 A61L-2209/12 A61M-011/04/1* A61M-2205/587 A61M-2205/6081 F21K-009/23 F21K-009/232 F21V-003/02 F21V-003/0615 F21V-019/00/6 F21V-023/04/35 F21V-023/04/42 F21V-029/506 F21V-029/83 F21V-033/00/04 F21V-033/00/56 F21W-2111/023 F21W-2121/00 F21Y-2103/37 F21Y-2113/13 F21Y-2113/20 F21Y-2115/10 H01J-005/54 H01J-061/32/7 H01J-061/70 H01K-001/46 H01R-031/06/5 H01R-033/94 H01R-033/945/3 H04R-001/02/8 H05B-033/08/03 H05B-033/08/09 H05B-033/08/18 H05B-033/08/57 H05B-033/08/63 H05B-033/08/66 H05B-033/08/72 H05B-035/00 H05B-037/02 H05B-037/02/09 H05B-037/02/18 H05B-037/02/27 H05B-037/02/36 H05B-037/02/72 H05B-037/02/9 H05B-041/282 H05B-041/282/8 Y02B-020/19 Y02B-020/383 Y02B-020/386 Y02B-020/44 Y02B-020/46 Y10S-362/81</p> <p><u>PCL - US patent classification</u> PCLO: 362231000* 362253000* 362276000* 362253000* 362096000* 362295000* PCLX: 362085000 362096000* 362101000 362227000 362253000* 362276000* 362643000 362650000 362810000</p>
--	--

Familie

US20070086199	A1	2007-04-19	   	US20080232091	A1	2008-09-25	   
US20070109763	A1	2007-05-17	   	US7476002	B2	2009-01-13	   
US20070109782	A1	2007-05-17	   	US7484860	B2	2009-02-03	   
US20070121319	A1	2007-05-31	   	WO2009020568	A1	2009-02-12	   
US20080001551	A1	2008-01-03	   	US7520635	B2	2009-04-21	   
WO2008002427	A1	2008-01-03	   	EP2073853	A2	2009-07-01	   
WO2008045569	A2	2008-04-17	   	EP2074869	A2	2009-07-01	   
WO2008045567	A2	2008-04-17	   	EP2074349	A2	2009-07-01	   
WO2008045531	A2	2008-04-17	   	EP2087775	A1	2009-08-12	   
WO2008051613	A1	2008-05-02	   	US7604378	B2	2009-10-20	   
WO2008045569	A3	2008-05-29	   	US7618151	B2	2009-11-17	   
WO2008045567	A3	2008-06-05	   	US7641364	B2	2010-01-05	   
WO2008045531	A3	2008-07-31	   	EP2074869	B1	2012-12-05	   
AR061624	A1	2008-09-10	   	ES2400816	T3	2013-04-12	   

(EP2087775)

A replacement device for a light bulb includes a translucent shell and a base. The base supports a plurality of colored lights positioned so as to emit a light show through the shell. The base is configured to be received in a conventional light socket. The base also includes a compartment for receiving and securing a replaceable volatile active cartridge for enabling the device to emit an active ingredient from the cartridge when the cartridge is secured in the compartment. A dimmable white light source may also be provided in the shell as a source of illumination. Thus, a single device is used as a replacement for a conventional light bulb and is a combination white light source/colored light show source/volatile active source.

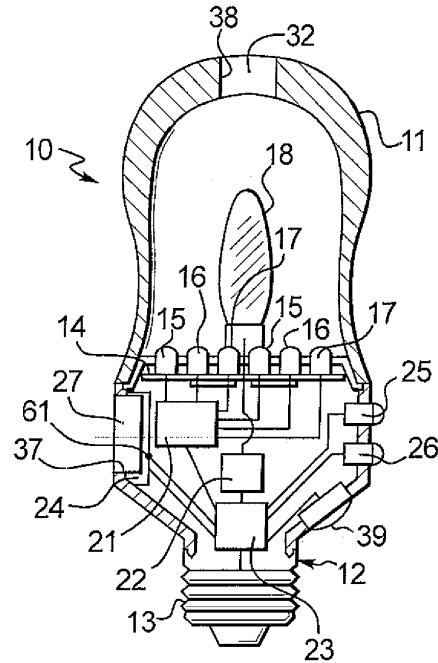

Motor vehicle flashing light and method for operating a turn signal lamp US20130127612 A1

<p><u>Current assignees</u> AUDI*</p> <p><u>Inventors</u> STADLER MANFRED SCHWARZ TORSTEN LENDLE REINER HUMMEL BENJAMIN</p> <p><u>Priority data including date</u> 2011DE-10119230 2011-11-23</p>	<p><u>IPC - International classification</u> B60Q-001/34 B60Q-001/38*</p> <p><u>CPC - Cooperative classification</u> B60Q-001/34* B60Q-001/38</p> <p><u>PCL - US patent classification</u> PCLO: 340465000*</p>
--	--

<u>Familie</u>	
<p>US20130127612 A1 2013-05-23 </p> <p>DE102011119230 A1 2013-05-23 </p> <p>EP2596993 A2 2013-05-29 </p> <p>CN103129450 A 2013-06-05 </p>	<p>DE102011119230 B4 2013-07-11 </p> <p>EP2596993 A3 2015-04-22 </p> <p>CN103129450 B 2016-08-03 </p>

(EP2596993)

The method involves arranging the light emitting diode (LED) groups (24 to 32) having multiple light emitting diodes (16) in a row (R). The primary LED group is switched-on from a switched-off state, and subsequently the other LED groups are successively switched-on until all the LED groups are switched-on. The LED groups are maintained in switched-on state for a predetermined time period and are finally switched-off. The time period from activation of the primary group until reaching the active state of all LED groups lie in the range of 100 milliseconds to 200 milliseconds. An independent claim is included for a motor vehicle direction indicator lamp with multiple light emitting diodes arranged in a row and interconnected to form multiple light emitting diode groups, and a control unit adapted to switch the light emitting diode groups.

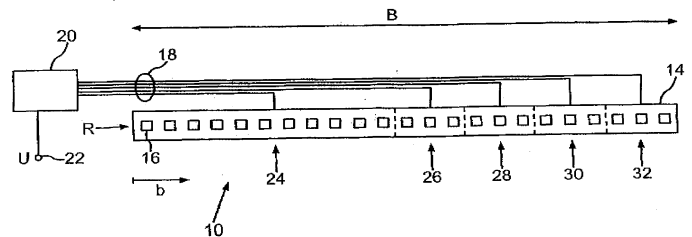

**After market sequential turn signal
US20120025970 A1**

<p><u>Current assignees</u> BEACH DONALD J WIGGINS EDMUND C</p> <p><u>Inventors</u> BEACH DONALD J WIGGINS EDMUND C</p> <p><u>Priority data including date</u> 2010US-12844269 2010-07-27</p>	<p><u>IPC - International classification</u> B60Q-001/34*</p> <p><u>CPC - Cooperative classification</u> B60Q-001/38* B60Q-001/44 B60Q-001/46 B60Q-2900/10</p> <p><u>PCL - US patent classification</u> PCLO: 340475000* PCLX: 340426180 340468000 340478000 340479000 362473000</p>
---	--

<u>Familie</u>	
US20120025970 A1 2012-02-02	US8310357 B2 2012-11-13

(US8310357)

A signal lamp control system for one rear side of a vehicle receives a signal or voltage from the vehicle (near side signal) originally intended to turn on all signal lamps on that side. Responsive to that signal, the signal lamp control system either turns on all signal lamps on that side or sequentially turns on the signal lamps on that side, depending on a status of a signal or voltage from the vehicle (far side signal) originally intended to control the signal lamps on the opposite rear side of the vehicle. In some embodiments, the signal lamp control system has knowledge of the state of the other side before the near side signal transitions on. This distinguishes between near-side signal activation (alone), brake activation, brake activation with near-side signal activation and hazard warning activation.

The diagram shows a front view of a vehicle's rear end. A license plate area contains the text 'HI-OFCER'. Various lamp assemblies are labeled with reference numerals: 10 points to the upper rear window area; 20 and 22 point to the left side lamp assembly; 24 points to a central lamp; 30 and 32 point to the right side lamp assembly; and 34 points to a central lamp on the right side.

Rear combination lamp US20100124073 A1

Current assignees

FORD GLOBAL TECHNOLOGIES*

Inventors

KOWALCZYK JOHN
PARTCH TOM WILLIAM
LOSSING JEFF SCOTT
ROSNER DOUGLAS GEORGE
SARIDAKIS GEORGE
ADAMS-CAMPOS KELLEY MARIA

Priority data including date

2008US-12272410 2008-11-17

IPC - International classification

B60Q-001/34	F21S-008/10*	F21V-015/02
F21V-021/00*	F21W-101/14	F21Y-101/02

CPC - Cooperative classification

B60Q-001/26/07*	B60Q-001/26/96	B60Q-011/00/7
F21S-043/14		

PCL - US patent classification

PCLO: 362545000*
PCLX: 362540000 362542000

Familie

US20100124073	A1	2010-05-20	   	US7963685	B2	2011-06-21	   
CN101737692	A	2010-06-16	   	CN101737692	B	2014-12-03	   

(US7963685)

A rear combination lamp y for a vehicle includes a rear combination lamp housing with an inboard cavity, an intermediate cavity, and an outboard cavity. First, second, and third light-emitting diodes extend into the inboard cavity, intermediate cavity, and outboard cavity, respectively. A turn signal member is operably connected to the first, second, and third light-emitting diodes and engagement of the turn signal activates the first, second, and third light-emitting diodes sequentially.

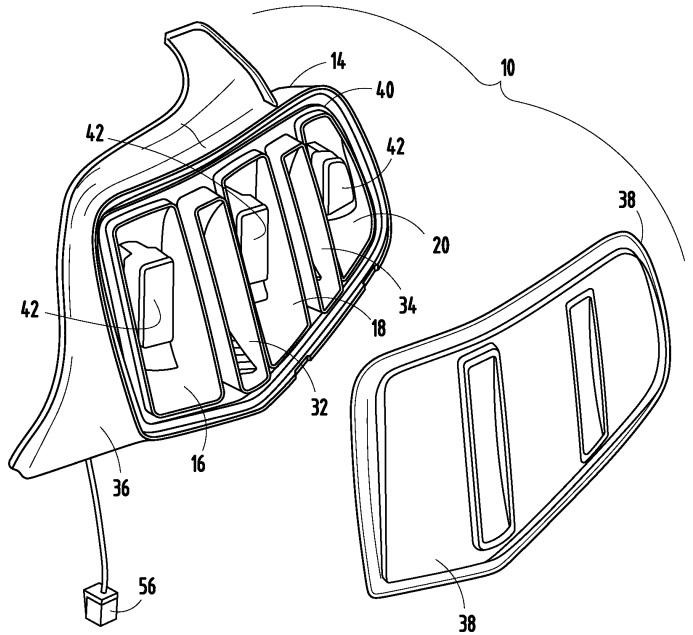

Adapter for a light source and at least one alternative luminous means DE102005049581 A1

<p><u>Current assignees</u> PATRA PATENT TREUHAND*</p> <p><u>Inventors</u> CUSTODIS UDO WEMMER GERT</p> <p><u>Priority data including date</u> 2005DE-10049581 2005-10-17 2006WO-EP67360 2006-10-12</p>	<p><u>IPC - International classification</u></p> <table style="width: 100%; border: none;"> <tr> <td style="border: none;">F21K-099/00*</td> <td style="border: none;">F21S-008/00</td> <td style="border: none;">F21V-019/00</td> </tr> <tr> <td style="border: none;">F21V-023/04</td> <td style="border: none;">F21V-023/06</td> <td style="border: none;">H01J-061/36</td> </tr> <tr> <td style="border: none;">H01R-031/06</td> <td style="border: none;">H01R-033/90</td> <td style="border: none;">H05B-035/00</td> </tr> </table> <p><u>CPC - Cooperative classification</u></p> <table style="width: 100%; border: none;"> <tr> <td style="border: none;">F21K-009/23</td> <td style="border: none;">F21V-019/00/6</td> <td style="border: none;">F21Y-2113/00</td> </tr> <tr> <td style="border: none;">F21Y-2115/10</td> <td style="border: none;">H01R-013/717/5</td> <td style="border: none;">H01R-033/90*</td> </tr> <tr> <td style="border: none;">H01R-033/92</td> <td></td> <td></td> </tr> </table>	F21K-099/00*	F21S-008/00	F21V-019/00	F21V-023/04	F21V-023/06	H01J-061/36	H01R-031/06	H01R-033/90	H05B-035/00	F21K-009/23	F21V-019/00/6	F21Y-2113/00	F21Y-2115/10	H01R-013/717/5	H01R-033/90*	H01R-033/92		
F21K-099/00*	F21S-008/00	F21V-019/00																	
F21V-023/04	F21V-023/06	H01J-061/36																	
H01R-031/06	H01R-033/90	H05B-035/00																	
F21K-009/23	F21V-019/00/6	F21Y-2113/00																	
F21Y-2115/10	H01R-013/717/5	H01R-033/90*																	
H01R-033/92																			

<u>Familie</u>													
DE102005049581	A1	2007-04-19					EP1938017	A1	2008-07-02				
WO2007045605	A1	2007-04-26					CN101287948	A	2008-10-15				
CA2626153	A1	2007-04-26					CN100575773	C	2009-12-30				

(EP1938017)

The invention discloses an adapter (1) for a light source (20) and at least one alternative luminous means (14a, 14b) having a base (4) for supplying electrical current, a lampholder (6) for the electrical connection between the base (4) and the light source (20) and at least two electrical contacts (12a, 12b) for supplying voltage to the alternative luminous means (14a, 14b). The lighting arrangement according to the invention has such an adapter and a luminous means mount (28, 38) for the alternative luminous means (14a, 14b).

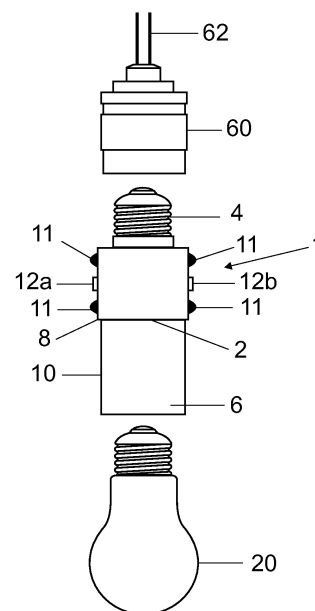

Colored headlamp US7008096 B1

Current assignees

OSRAM SYLVANIA*

Inventors

COUSHAINÉ CHARLES M

TESSNOW THOMAS

TUCKER MICHAEL-D

Priority data including date

2005US-11064239 2005-02-23

2006US-11332749 2006-01-13

IPC - International classification

B60Q-001/04	F21S-002/00	F21S-008/00
F21S-008/10*	F21S-008/12	F21V-005/00
F21V-005/08	F21V-007/00	F21V-017/00
F21V-019/00	F21V-023/00	F21V-029/00
F21W-101/10	F21Y-101/00	F21Y-113/02
G02B-006/00	H01L-033/58	





























































CPC - Cooperative classification

B60Q-2400/30	F21S-041/125	F21S-041/143
F21S-041/147*	F21S-041/28*	F21Y-2113/00
F21Y-2115/10	H01L-033/58	

PCL - US patent classification

PCLO:	362545000*	362544000*	
PCLX:	257E33073	362228000	362540000
	362545000*	362551000	

Familie

US7008096	B1	2006-03-07	   	EP1696170	A1	2006-08-30	   
CA2530570	A1	2006-08-23	   	JP2006237006	A	2006-09-07	   
US20060187671	A1	2006-08-24	   	US7261451	B2	2007-08-28	   
KR20060094032	A	2006-08-28	   	JP4921809	B2	2012-04-25	   
KR20060094031	A	2006-08-28	   	CA2530570	C	2013-07-02	   
CN1824993	A	2006-08-30	   	KR101344381	B1	2013-12-24	   
CN1824992	A	2006-08-30	   	EP1696172	B1	2017-05-24	   
EP1696172	A1	2006-08-30	   				

(EP1696172)

A vehicle headlamp (10) has a first light source (12) for illuminating an area forward of the light source (12). The first light source (12) is preferably a filamented tungsten halogen capsule or an arc discharge source. The first light source (12) is arrayed along a longitudinal axis (14) and emits substantially white light. A second light source (16) in the form of a plurality of light emitting diodes is arrayed about the first light source (12), and the second light source (16) emits light via an optic 42 for providing a daylight running light. Via the optic 42 light is emitted in a forward direction as well as toward the reflector to increase the lighting area.

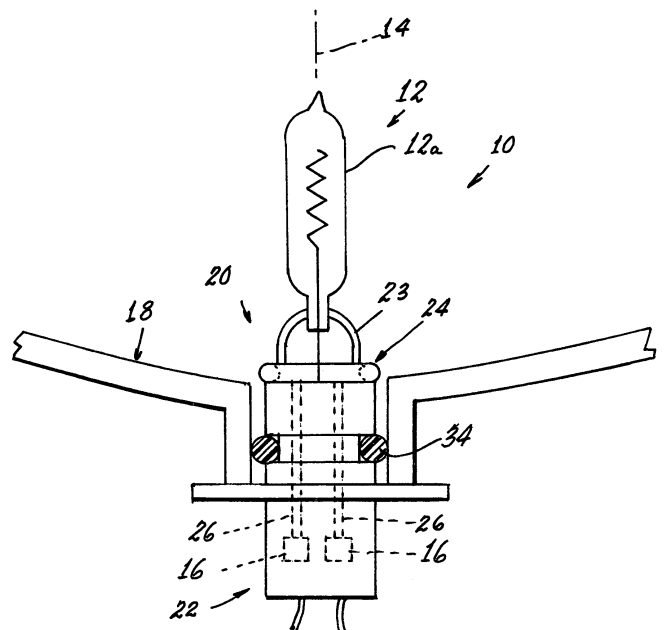

Lighting unit WO200578335 A1

Current assignees

PHILIPS
PHILIPS ELECTRONICS*

Inventors

VAN DER POEL LUCAS L D

Priority data including date

2004EP-0100487 2004-02-10
2005EP-0702827 2005-01-28
2005WO-IB50376 2005-01-28

IPC - International classification

B60Q-001/26	F21K-099/00	F21S-002/00
F21S-006/00	F21S-008/00*	F21S-008/04
F21S-010/02	F21V-017/06	F21V-019/00
F21V-021/00	F21V-021/26	F21V-023/00
F21V-023/04	F21V-029/00	F21V-033/00
F21Y-101/00	F21Y-101/02	H01R-013/66
H01R-031/00	H01R-033/00	H01R-033/94

CPC - Cooperative classification

























































F21K-009/23	F21S-006/00	F21S-010/02
F21V-019/00/6*	F21V-023/04/35	F21Y-2113/20
F21Y-2115/10	H01R-013/66/41	H01R-033/94

PCL - US patent classification

PCLO: 362227000*

PCLX: 362095000 362184000 362249100
362269000 362429000 362435000 362650000
439642000

Familie

WO2005078335	A1	2005-08-25	   	US7556398	B2	2009-07-07	   
TW200536150	A	2005-11-01	   	CN1918425	B	2010-10-13	   
EP1716362	A1	2006-11-02	   	EP1716362	B1	2010-12-01	   
KR20060123525	A	2006-12-01	   	AT490436	T	2010-12-15	   
CN1918425	A	2007-02-21	   	DE602005025085	D1	2011-01-13	   
JP2007522618	A	2007-08-09	   	JP4653120	B2	2011-03-16	   
US20080144311	A1	2008-06-19	   	ES2357239	T3	2011-04-20	   

(EP1716362)

The invention relates to a lighting unit, comprising a first light element formed as a conventional light source, a second light element formed as a plurality of LEDs and a lamp cap. According to the invention the second light element is formed as a separate LED- module with a fitting and a second lamp cap whereby the first and the second light elements are removably attached via the fitting and the second lamp cap, the fitting and second lamp cap providing electrical and mechanical connection between both light elements. The invented lighting unit is cost-effective and has better mixing possibilities of the light produced by both light elements.

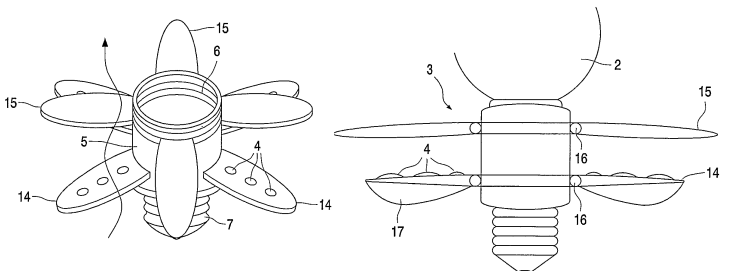

Illumination device with arms that open after passing through a hole US20050099810 A1

<p><u>Current assignees</u> LIAO RONNY TASSON ANTONIO</p> <p><u>Inventors</u> TASSON ANTONIO LIAO RONNY</p> <p><u>Priority data including date</u> 2003US-60517946 2003-11-06 2004US-10966323 2004-10-15</p>	<p><u>IPC - International classification</u> B60Q-001/26 F21K-099/00 F21S-008/10 F21V-021/14 F21V-021/26*</p> <p><u>CPC - Cooperative classification</u> B60Q-001/26/07* F21K-009/65 F21S-043/14 F21S-043/15 F21V-021/30 F21Y-2115/10</p> <p><u>PCL - US patent classification</u> PCLO: 362249070* PCLX: 248168000 248435000 362429000 362581000</p>
---	---

<u>Familie</u>	
<p>US20050099810 A1 2005-05-12 US7407304</p>	<p>B2 2008-08-05 </p>

(US7407304)

An illumination device including at least one arm supporting one or more light emitting devices, such arm pivoting from a closed configuration for passing through a hole to an open configuration for function. In a preferred embodiment, the illumination device includes three or five arms, light emitting diodes (LEDs) as the light emitting devices and, springs for automatically pivoting the arms to the open configuration.

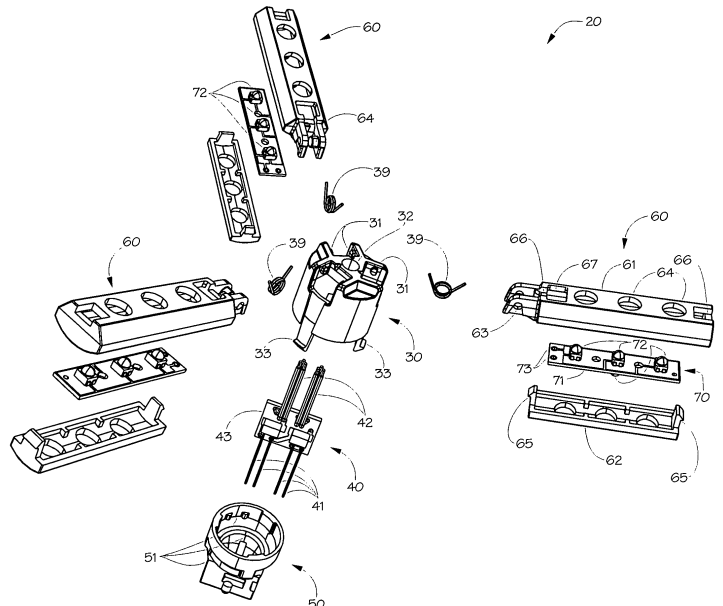

Lighting device US20040264187 A1

Current assignees

VANDERSCHUIT CARL R.

Inventors

VANDERSCHUIT CARL R

Priority data including date

2003US-10606324 2003-06-25

2004US-10541097 2004-06-10

2004WO-US18799 2004-06-10

IPC - International classification

F21L-004/02	F21S-006/00	F21S-008/00
F21S-009/02	F21S-019/00	F21V-001/00
F21V-003/02	F21V-019/00*	F21V-023/04
F21Y-101/02	H01R-033/94	H01R-033/955
H05B-037/02	H05B-039/04	

CPC - Cooperative classification

F21K-009/23	F21L-004/02/7	F21S-006/00
F21S-006/00/5	F21S-009/02/2	F21V-003/02
F21V-019/00/6	F21V-023/04/42	F21W-2121/00
F21Y-2113/00	F21Y-2113/20	F21Y-2115/10
H01R-033/94	H01R-033/955/5	H05B-035/00*
H05B-037/02/09	H05B-039/04/1	

PCL - US patent classification

PCLO:	362235000*	362228000*
PCLX:	362229000	362650000

Familie

[US20040264187](#)

A1 2004-12-30



[WO2005045312](#)

A1 2005-05-19

[EP1639293](#)

A1 2006-03-29

[US20060146527](#)

A1 2006-07-06

[CN1833136](#)

A 2006-09-13

[EP1639293](#)

A4 2008-12-31



(EP1639293)

Lighting devices and methods include a base portion for engaging a light socket, and a socket for receiving a light bulb. At least one light source is coupled to the base portion. The base portion is electrically connected to the device's socket to apply electrical power from the light socket to the light bulb. The base portion can also be electrically connected to the light source to apply electrical power from the light socket to the light source.

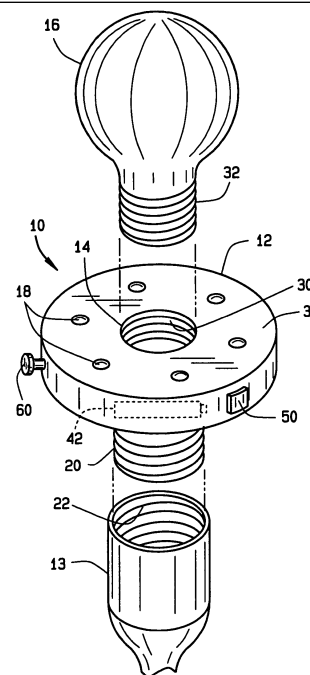

Light emitting diodes surrounding a vehicle lamp US6756893 B1

<p><u>Current assignees</u> FERNANDEZ ROBERT</p> <p><u>Inventors</u> FERNANDEZ ROBERT</p> <p><u>Priority data including date</u> 2002US-10047887 2002-01-14</p>	<p><u>IPC - International classification</u></p> <table style="width: 100%; border: none;"> <tr> <td style="border: none;">B60Q-001/00*</td> <td style="border: none;">B60Q-001/26</td> <td style="border: none;">B60Q-011/00</td> </tr> <tr> <td style="border: none;">F21S-008/00</td> <td style="border: none;">F21S-008/10</td> <td style="border: none;">F21V-019/04</td> </tr> <tr> <td style="border: none;">H05B-035/00</td> <td style="border: none;">H05B-039/10</td> <td></td> </tr> </table> <p><u>CPC - Cooperative classification</u></p> <table style="width: 100%; border: none;"> <tr> <td style="border: none;">B60Q-001/00/52</td> <td style="border: none;">B60Q-001/26</td> <td style="border: none;">B60Q-011/00/2</td> </tr> <tr> <td style="border: none;">F21S-041/00</td> <td style="border: none;">F21S-043/14</td> <td style="border: none;">F21V-019/04*</td> </tr> <tr> <td style="border: none;">F21Y-2113/00</td> <td style="border: none;">F21Y-2113/20</td> <td style="border: none;">F21Y-2115/10</td> </tr> <tr> <td style="border: none;">H05B-035/00</td> <td style="border: none;">H05B-039/10</td> <td></td> </tr> </table> <p><u>PCL - US patent classification</u></p> <p>PCLO: 340458000*</p> <p>PCLX: 315077000 315088000 362249050</p>	B60Q-001/00*	B60Q-001/26	B60Q-011/00	F21S-008/00	F21S-008/10	F21V-019/04	H05B-035/00	H05B-039/10		B60Q-001/00/52	B60Q-001/26	B60Q-011/00/2	F21S-041/00	F21S-043/14	F21V-019/04*	F21Y-2113/00	F21Y-2113/20	F21Y-2115/10	H05B-035/00	H05B-039/10	
B60Q-001/00*	B60Q-001/26	B60Q-011/00																				
F21S-008/00	F21S-008/10	F21V-019/04																				
H05B-035/00	H05B-039/10																					
B60Q-001/00/52	B60Q-001/26	B60Q-011/00/2																				
F21S-041/00	F21S-043/14	F21V-019/04*																				
F21Y-2113/00	F21Y-2113/20	F21Y-2115/10																				
H05B-035/00	H05B-039/10																					

<p><u>Familie</u></p> <p>US6756893</p>	<p>B1 2004-06-29</p>	
---	----------------------	--

(US6756893)

A plurality of light emitting diodes are mounted on a base that encircles or surrounds a primary vehicle light source such as a headlight, a taillight, a turn signal light or the like. A control circuit senses when the primary light source fails to provide the requisite light, and applies power to the light emitting diodes so that the vehicle can continue safely without loss of the function served by the primary light source. Additional diodes may be provided on the base to serve an ornamental function.

Sequential direction indicators for motor vehicles and street signs

DE19534410 A1

<p>Current assignees GFK KUNSTSTOFFVERARBEITUNG*</p> <p>Inventors EHMKE MANFRED</p> <p>Priority data including date 1995DE-1034410 1995-09-16</p>	<p>IPC - International classification B60Q-001/30* B60Q-001/38 E01F-009/50 E01F-013/02</p> <p>CPC - Cooperative classification B60Q-001/30/2 B60Q-001/38* E01F-009/50 E01F-013/02</p>
--	---

Familie

[DE19534410](#)

A1 1997-03-20



[DE19534410](#)

C2 2000-02-10



(DE19534410)

A sequential turn signal for a car is located on the front and back of the car and comprises individual lamps, luminescent diodes or similar items forming a light chain. At least three lamps about two inches apart form one chain. The time interval between adjacent lamps illuminating is at least a hundred milliseconds. The same light chain can be used on traffic diversion signboards or instead of the white arrows used to designate different lane directions at traffic intersections. The light intensity increases towards the end of the light travel, or the lamps can have a transparent cover that permits increased transmissivity in the end-of-light-travel region.

